

OUTBOARD MOTOR
HONDA

BF75-100

OWNER'S MANUAL

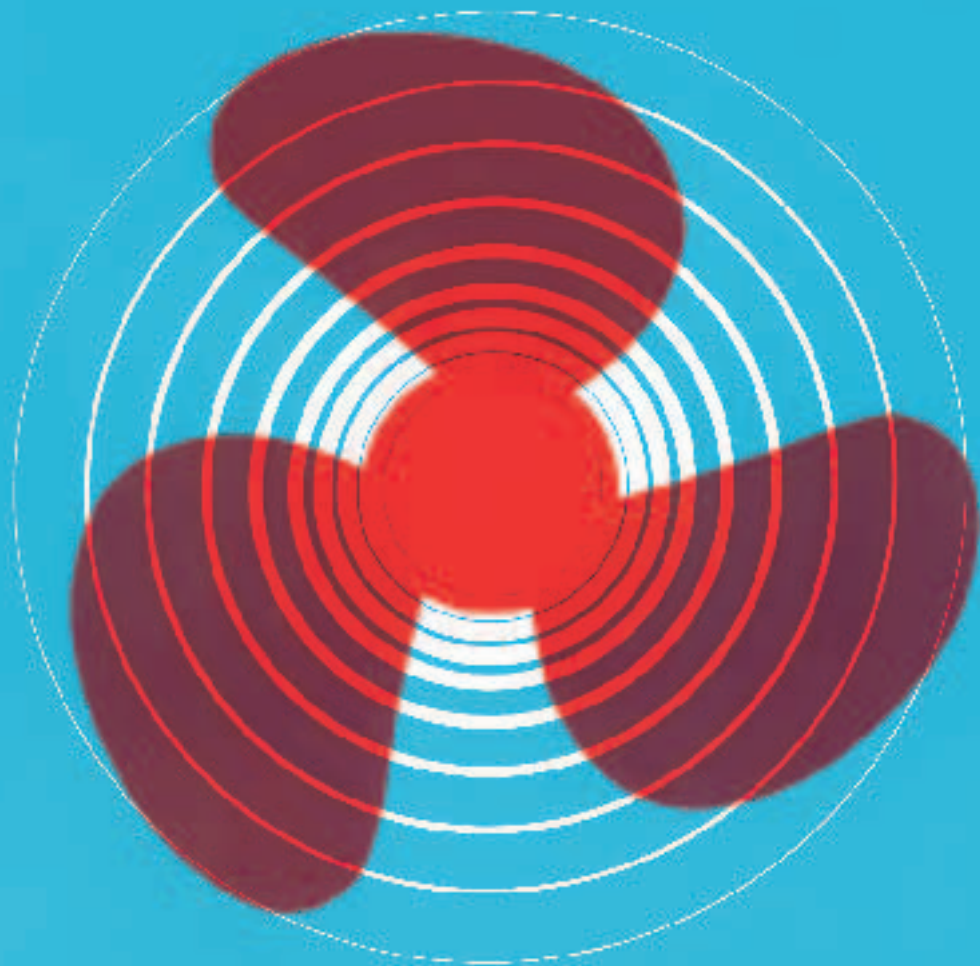

Thank you for purchasing a Honda Outboard Motor.

This manual covers operation and maintenance of the Honda Outboard Motor. All information in this publication is based on the latest product information available at the time of approval for printing.

Honda Motor Co., Ltd. reserves the right to make changes at any time without notice and without incurring any obligation.

No part of this publication may be reproduced without written permission.

This manual should be considered a permanent part of the Outboard Motor and should remain with the Outboard Motor when it is sold.

Pay special attention to statements preceded by the following words:

 WARNING Indicates a strong possibility of severe personal injury or loss of life if instructions are not followed.

CAUTION: Indicates a possibility of personal injury or equipment damage if instructions are not followed.

NOTE: Gives helpful information.

If a problem should arise, or if you have any questions about the Outboard Motor, consult an authorized Honda dealer.

 WARNING Honda Outboard Motors are designed to give safe and dependable service if operated according to instructions. Read and understand the Owner's Manual before operating the Outboard Motor. Failure to do so could result in personal injury or equipment damage



1. SAFETY INSTRUCTIONS	4
2. WARNING LABELS	5
3. COMPONENT IDENTIFICATION	6
4. INSTALLATION	8
5. PRE-OPERATION CHECK	10
6. STARTING THE ENGINE	13
7. OPERATION	18
8. STOPPING THE ENGINE	24
• High altitude operation	24
9. MAINTENANCE	25
10. TRANSPORTING/STORAGE	36
11. TROUBLESHOOTING	38
12. SPECIFICATIONS	39
13. WIRING DIAGRAM	40
14. OPTIONAL PARTS	41
15. WARRANTY SERVICE	42

1. SAFETY INSTRUCTIONS

WARNING

To ensure safe operation—

- Understand the operation of all controls, and know how to stop the engine quickly — **READ THIS OWNER'S MANUAL CAREFULLY.**
- Do not exceed the boat manufacturer's power recommendation, and be sure the outboard motor is properly mounted.
- Never permit anyone to operate the outboard motor without proper instruction.
- Stop the engine immediately if any passenger falls overboard.
- Do not run the motor while the boat is near any person in the water.
- Exhaust gas contains poisonous carbon monoxide. Never run the outboard motor in a closed garage or confined area.
- Gasoline is extremely flammable and is explosive under certain conditions. Refuel in a well ventilated area with the engine stopped.
- Do not smoke or allow flames or sparks where the engine is refueled or where gasoline is stored.
- Do not overfill the fuel tank, and make sure the fuel tank cap is securely closed after refueling.
- Be careful not to spill fuel when refueling. Fuel vapor or spilled fuel may ignite. If any fuel is spilled, make sure the area is dry before starting the engine.

2. WARNING LABELS

FRONT LABEL

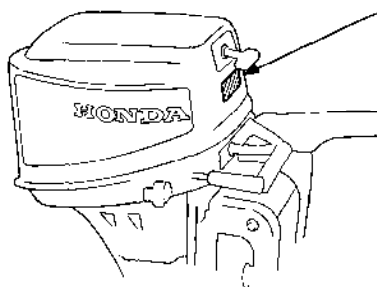

- CAUTION** Check oil level before starting.
- PRECAUTION** Contrôler obligatoirement le niveau d'huile avant de démarrer.

HONDA

STARTING CAUTION LABEL

START ENGINE WITH TRANSMISSION IN NEUTRAL

- DO NOT OPERATE WITH ENGINE COVER REMOVED.
- PULL STARTER LIGHTLY UNTIL SOME RESISTANCE IS FELT. THEN PULL HARD AND FAST.

METTRE LE MOTEUR EN MARCHÉ AVEC LE LEVIER DES VITESSES AV POINT MORT.

- NE PAS FAIRE FONCTIONNER LE MOTEUR LE CAPOT RELEVÉ.
- TIRER LE LANCEUR DOUCEMENT. PUIS FORIEMENT A LA COMPRESSION.

CAMSHAFT PULLEY LABEL

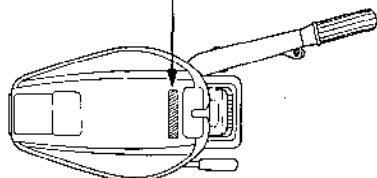
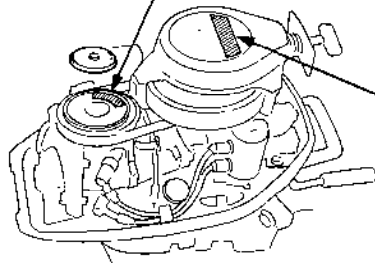
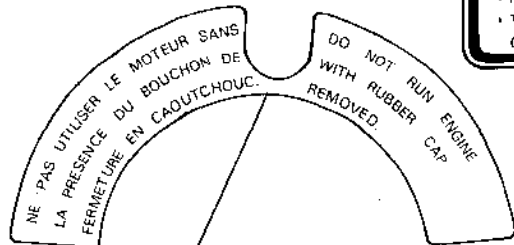

RECOIL STARTER CAUTION LABEL

- MISE EN ROUTE PAR CORDE LANCEMENT
- DEMONTAGE-DESSERRER LES TROIS ECRUS DE 6 MM.
- DEMONTAGE-ENROULER LA CORDE AUTOUR DE LA POIGNEE PLUS TARD.
- FAIRE ATTENTION AUX PARTIES ROTATIVES.

- EMERGENCY STARTING PROCEDURE
- REMOVE THE RECOIL STARTER BY REMOVING THE THREE 6 MM BOLTS.
- WIND THE SPARE ROPE CLOCKWISE AROUND THE PULLEY TO START THE ENGINE. CAUTION-KEEP CLEAR OF MOVING PARTS.
- REINSTALL THE ENGINE COVER.

FUEL TANK CAUTION LABEL



Wipe off spilled gasoline completely.

GASOLINE ONLY

13 liters

ESSENCE SEULEMENT

2.9 Imp. gal

3.4 U.S. gal

Essuyer toute essence renversée.

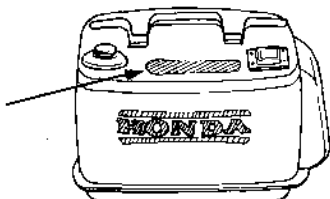

3. COMPONENT IDENTIFICATION

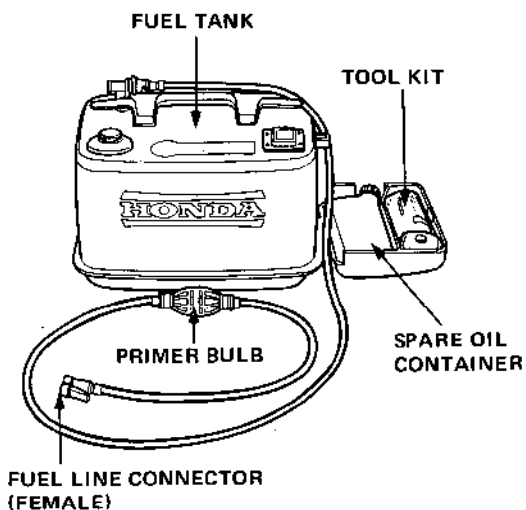
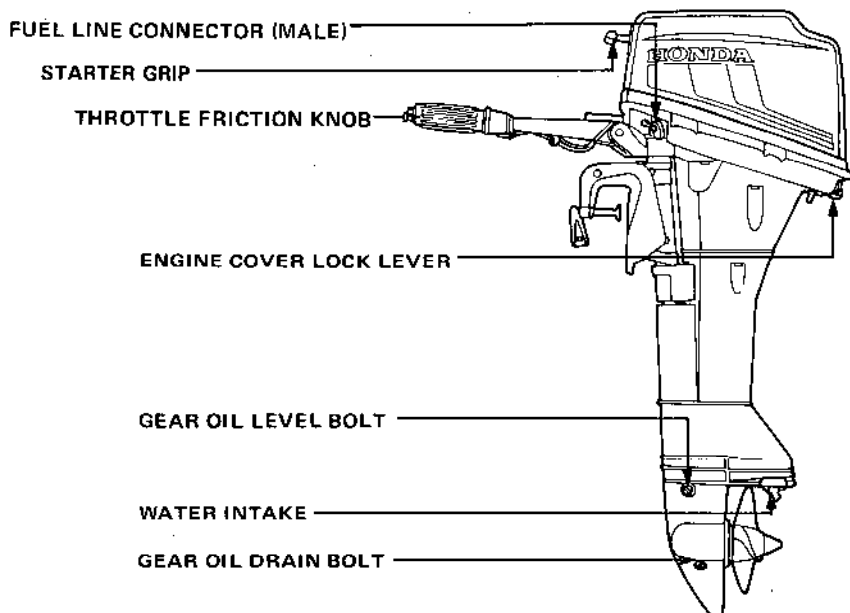

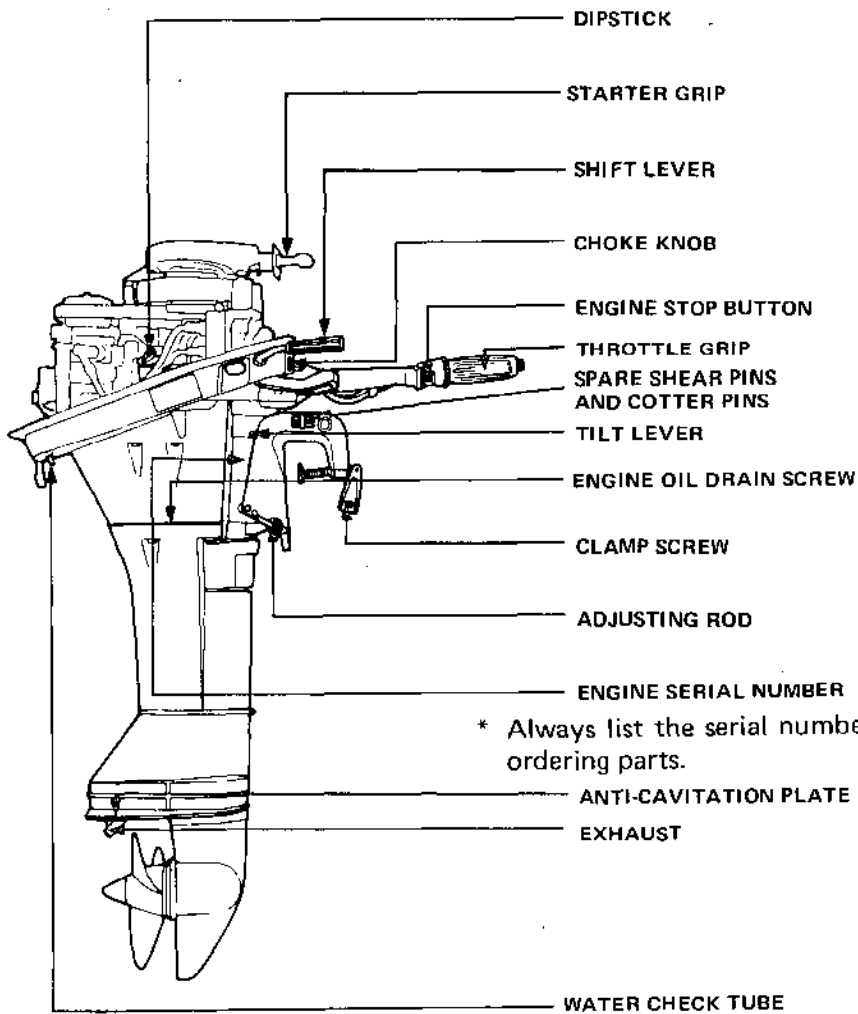

4. INSTALLATION

It is your responsibility to choose a boat suitable for the engine (9.9 horsepower BF100, 7.5 horsepower BF75).

WARNING Do not exceed the boat manufacturer's power recommendation. Damage and injury may result.

1. Installation Position

Install at the stern at the center line of the boat.

2. Installation Height

Make sure that the transom height is correct for the motor. Incorrect installation height will reduce performance.

The motor should be installed so that the anti-cavitation plate is 2–5 cm (0.8–2.0 in) below the bottom of the boat.

CAUTION: The water level must be at least 4 inches above the anticavitation plate, otherwise the water pump may not receive sufficient cooling water, and the engine will overheat.

3. Motor Attachment

Attach the stern bracket to the transom and tighten the clamp screws.

CAUTION:

- While operating the boat, check the tightness of the clamp screws occasionally.
- Tie a rope through the hole in the stern bracket and secure the other end of the rope to the boat. This will prevent accidental loss of the motor.

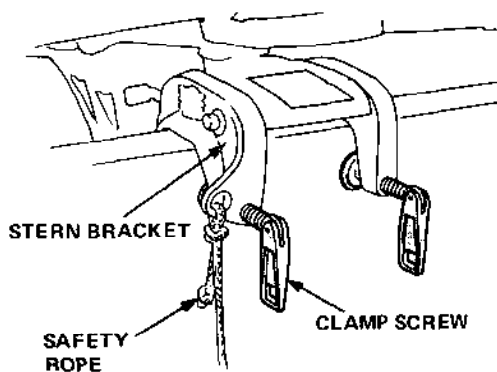
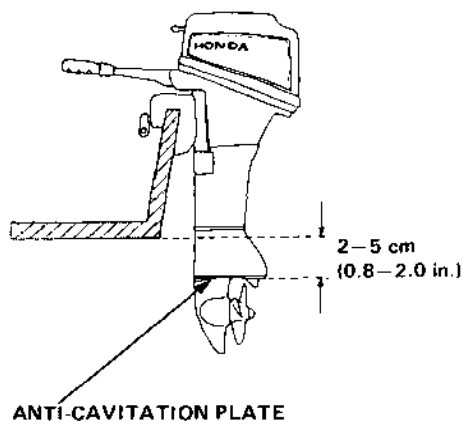
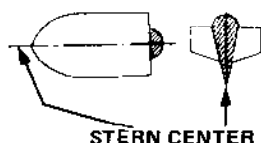
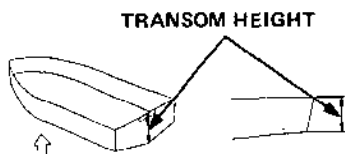

4. Motor Angle (In cruising)

Adjust the motor so the axis of the propeller is parallel with the water surface.

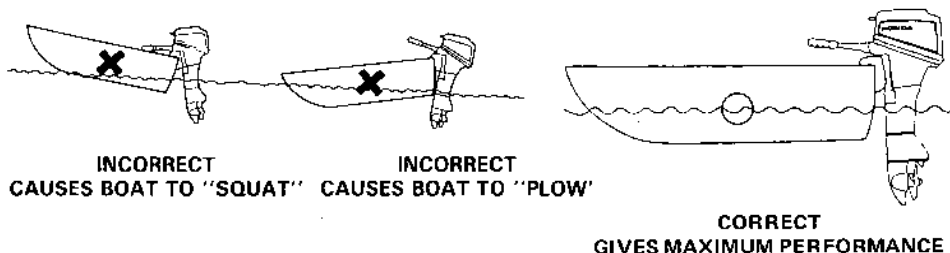

5. Motor Angle Adjustment

If the propeller axis is not parallel with the water surface, adjust by changing the adjusting rod position. There are four adjusting stages.

1. Push in (A) the adjusting rod, twist upwards (B) and pull out to remove.
2. Inserting the rod in the proper hole, twist it down to lock.

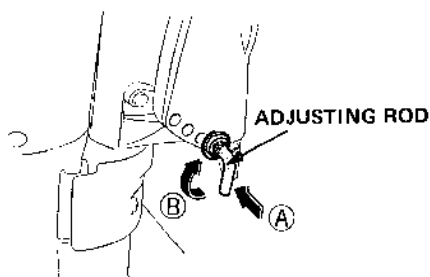

CAUTION: To prevent damage to the motor or boat, make sure the adjusting rod is locked.

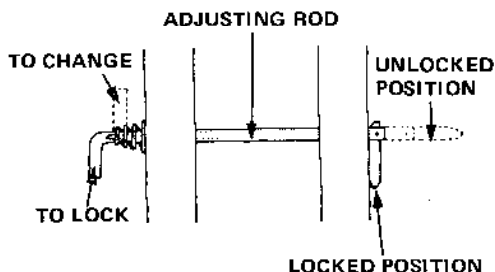

5. PRE-OPERATION CHECK

1. Check the engine oil level.

CAUTION:

- Engine oil is a major factor affecting engine performance and service life. Non-detergent and low quality oils are not recommended.
- Running the engine with insufficient oil can cause serious engine damage.

Use Honda 4-stroke oil, or an equivalent high detergent, premium quality motor oil certified to meet or exceed U.S. automobile manufacturer's requirements for Service Classification SE or SF. (Motor oils classified SE or SF will show this designation on the container.)

Select the appropriate viscosity for the average temperature in your area. SAE 10W-40 is recommended for general, all-temperature use.

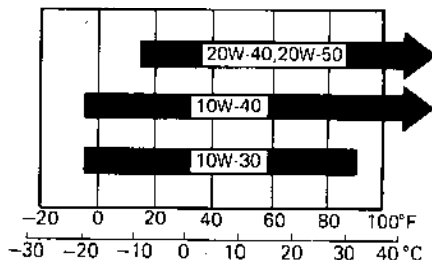

1. Position the outboard motor vertically, and remove the engine cover.
2. Remove the dipstick and wipe with a clean rag.
3. Reinsert the dipstick, and check the oil level with the dipstick resting on the filler opening (do not screw in). If the oil level is down toward the 400 cc mark, fill to the 800 cc mark.

Oil capacity: 0.8 ℓ (0.85 US qt)

ENGINE COVER LOCK LEVER

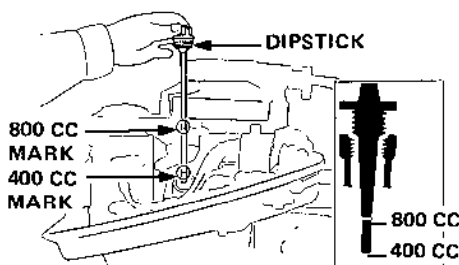
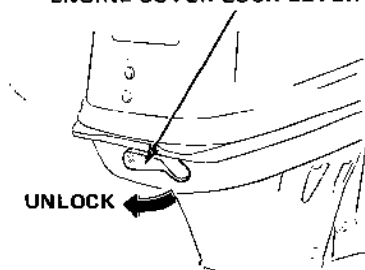

2. Check the fuel level

Check the fuel gauge and refill the tank if the fuel level is low.

NOTE: Open the vent knob before removing the fuel filler cap. When the vent knob is firmly closed, the cap will be difficult to remove.

Use any regular grade automotive gasoline (unleaded gasoline is preferred) with a pump octane rating of 86 or higher. Never use an oil/gasoline mixture or dirty gasoline. Avoid getting dirt, dust or water in the fuel tank.

CAUTION: Gasoline substitutes are not recommended; they may be harmful to the fuel system components.

Fuel tank capacity: 13 ℓ (3.4 US gal)

WARNING

- Gasoline is extremely flammable and explosive under certain conditions. Refuel in a well ventilated area with the engine stopped.
- Do not smoke or allow flames or sparks near the fuel tank and fuel line.
- Do not overfill the tank and make sure the filler cap is securely closed after refueling.
- Be careful not to spill fuel when refueling. Fuel vapor or spilled fuel may ignite. If any fuel is spilled, make sure the area is dry before starting the engine.

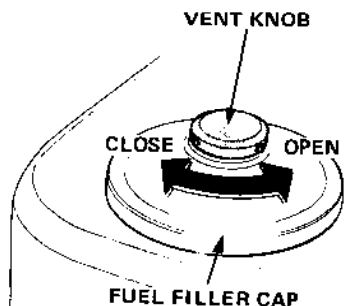
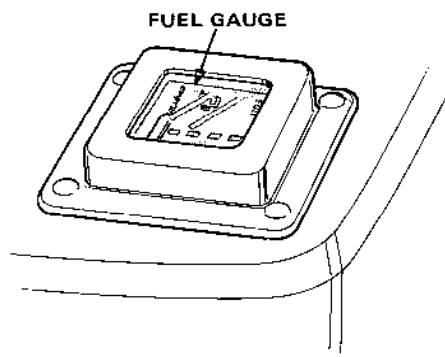

3. Check the following items.

- Check the propeller, the shear pin, and the cotter pin to be sure they are secure and undamaged.
- Check the stern bracket to be sure the motor is securely installed.
- Check steering handle operation.
- Make sure you have the tool kit and spare parts with you (P. 26).

6. STARTING THE ENGINE

CAUTION: Damage to the water pump, engine components and exhaust system may occur if the motor is operated while the propeller is out the water.

1. Connect the fuel line to the tank and outboard motor, as shown. Be sure the connectors are securely latched.

NOTE:

- Position the fuel tank so the tank fuel line connector is no more than 1 meter (3.3 ft) below the motor fuel line connector.
- Do not place the fuel tank more than 2 meters (6.6 ft) away from the motor.
- Be sure that the fuel line is not kinked.

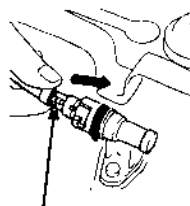

**MALE FUEL LINE CONNECTOR
- TO FUEL TANK**

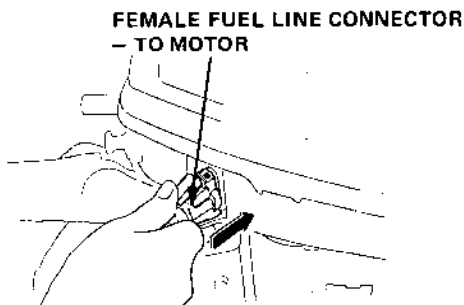

**FEMALE FUEL LINE CONNECTOR
- TO MOTOR**

2. Open the fuel cap vent knob 2 to 3 turns.
3. Squeeze and release the primer bulb until it feels firm, indicating that fuel has reached the motor. Check for leaks.

WARNING If any fuel is spilled, make sure the area is dry before starting the engine. Spilled fuel may ignite.

NOTE: Do not use the primer bulb while the engine is running.

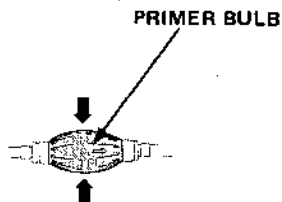
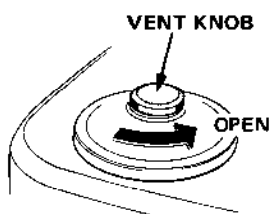

Starting

1. Put the shift lever in **NEUTRAL**.

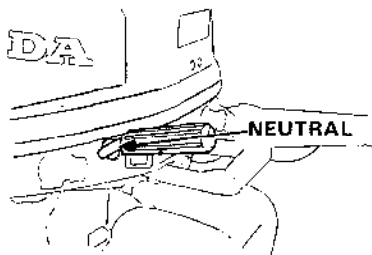

2. Align the throttle grip **START** position with the mark on the steering handle.

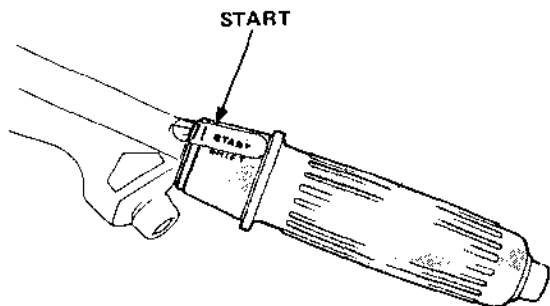

3. In temperatures below 20°C (68°F) use the choke knob.

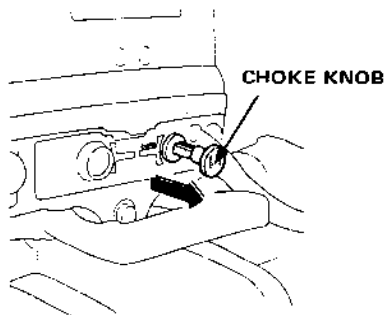

4. Pull the starter rope slowly until a resistance is felt, then pull briskly.

NOTE: Do not allow the starter grip to snap back. Return it slowly by hand.

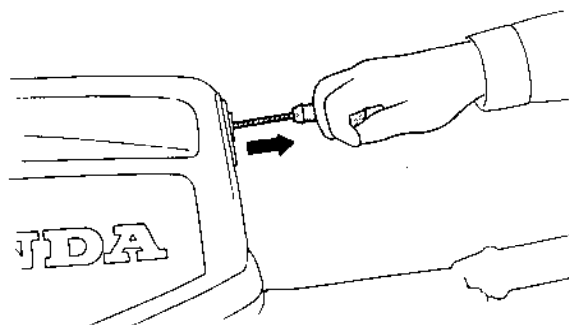

5. The oil pressure indicator lamp should be on while the engine is running above idle speed. If the lamp goes off, stop the engine immediately, check the engine oil level and inspect engine for oil leaks.

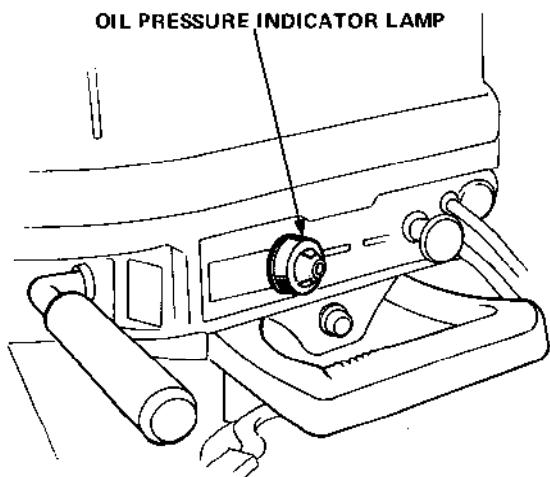

6. After starting, be sure water is flowing out of the water check tube.

CAUTION: If water does not flow out, or if steam comes out, stop the engine. Check to see if the screen in the cooling water inlet is obstructed. Do not operate the engine until the problem has been corrected.

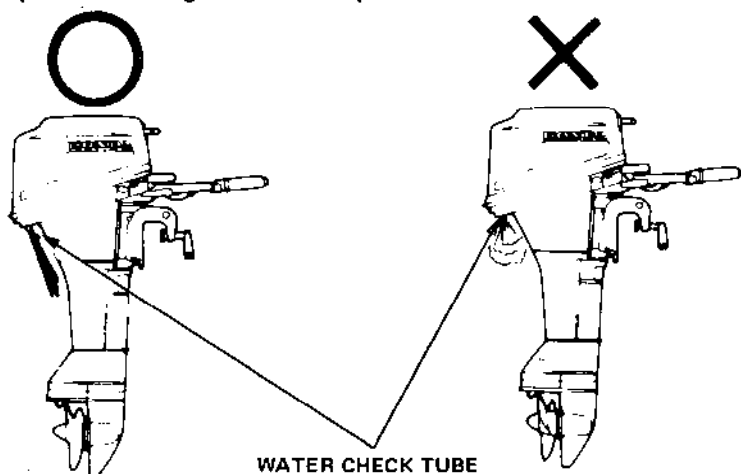

7. If the choke was used, push it in gradually as the engine warms up.

Emergency Starting

If the recoil starter is not working properly, the engine can be started with the spare starter rope in the tool kit.

1. Remove the engine cover.
2. Remove the recoil starter by removing the three 6 mm bolts.
3. Wind the spare rope clockwise around the pulley to start the engine.

CAUTION: Keep clear of moving parts.

4. Reinstall the engine cover.

CAUTION: Do not operate without the engine cover. Exposed moving parts could cause injury and water may damage the engine.

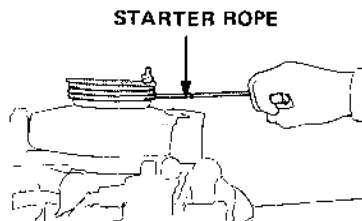
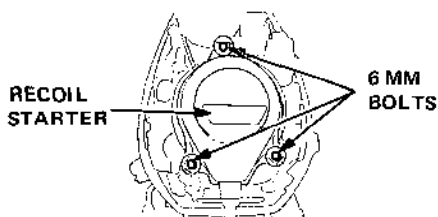

7. OPERATION

1. Gear Shifting

The engine has 3 gears: FORWARD, NEUTRAL, and REVERSE. An indicator at the base of the gear shift lever aligns with the letters F, N, or R on the engine case to show the gear that has been selected.

Turn the throttle grip to SHIFT to decrease engine speed before moving the gear shift lever.

CAUTION: When operating in reverse, proceed with caution to avoid hitting any underwater obstruction with the propeller.

NOTE: The throttle mechanism is designed to limit throttle opening in REVERSE and NEUTRAL. The throttle can be opened to FAST only in FORWARD gear.

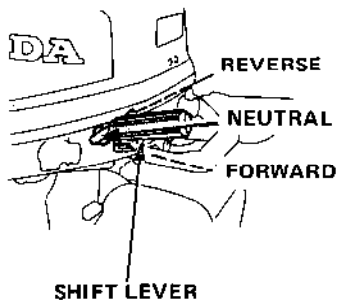
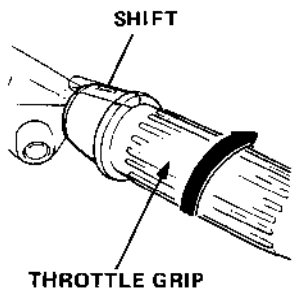

2. Steering

To turn to the right, swing the steering handle to the left. To turn to the left, swing the handle to the right. Boats equipped with a remote control steering wheel are controlled in the same way as a car.

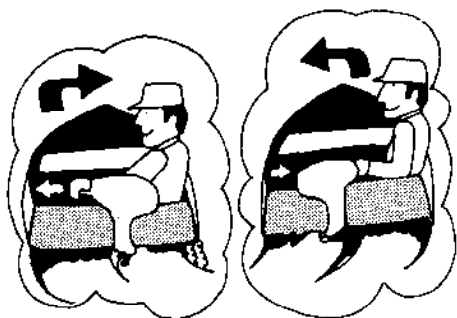

For smooth steering, adjust the steering friction bolt so that a slight drag is felt when turning.

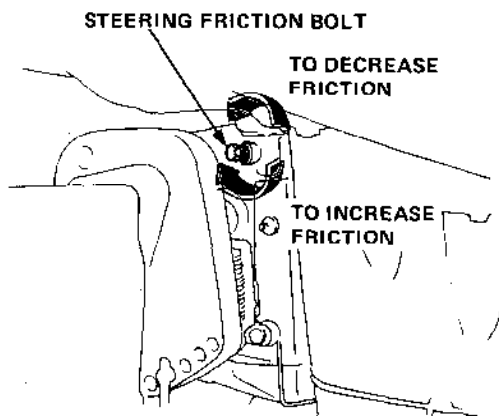

3. Cruising

With the shift lever in the forward position F, turn the throttle grip toward **FAST** to increase speed. For normal cruising, open the throttle about 3/4.

To hold the throttle at a steady setting, turn the throttle friction knob clockwise. To free the throttle grip for manual speed control, turn the friction knob counter-clockwise.

NOTE: For best performance, passengers and equipment should be distributed to balance the boat evenly from side to side and parallel to the water from front to back.

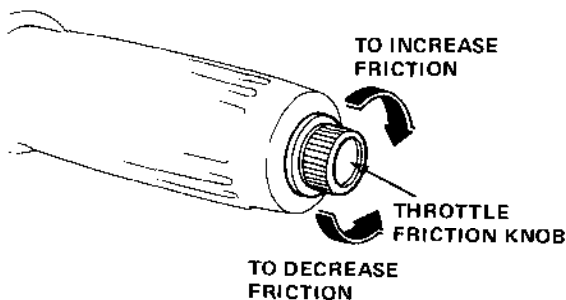
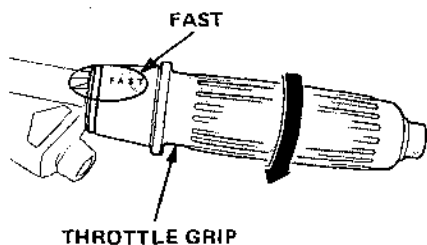
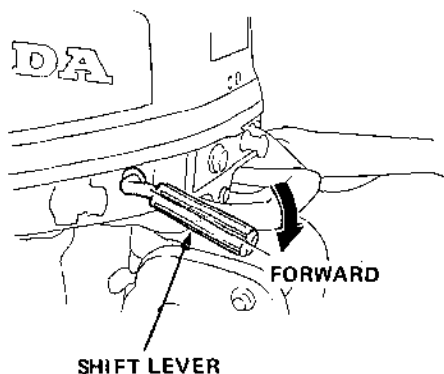

4. Tilting the Motor

Tilt the motor to prevent the propeller and gear case from hitting bottom when the boat is beached or stopped in shallow water.

1. Stop the engine and put the shift lever into **NEUTRAL**.
2. Pull the tilt lever toward you, set the lever in the **TILT** position, and raise the engine to either the 32.5° or 72° tilt position.
3. To return the engine to the normal **RUN** position, move the tilt lever away from you until it stops, tilt the engine slightly, then lower the engine slowly.

CAUTION: Do not transport the motor in the tilted position; it may drop suddenly causing damage to the boat or the motor.

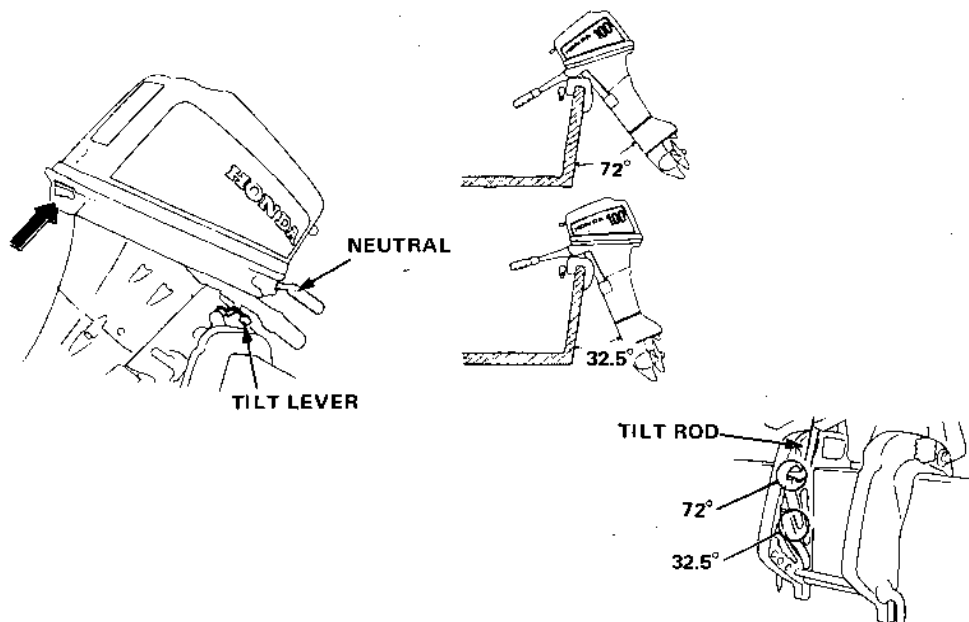

CAUTION: To avoid damaging the motor, use the utmost care when mooring a boat, especially when its motor is tilted up. Don't allow the motor to strike against the pier or other boats.

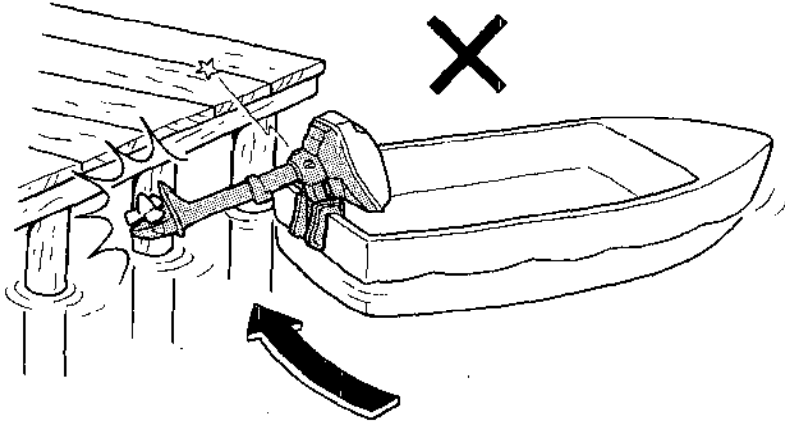

CAUTION: To avoid damaging the motor, never use it as a handle for lifting or moving the boat.

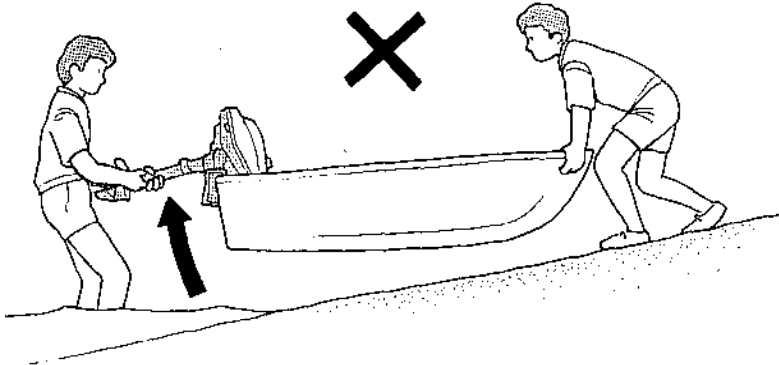

5. Battery Charging and Lighting

The DC receptacle provides a 12 V, 60 W current for 12 V battery charging and lighting. The circuit is protected by a 5 A fuse that is accessible by removing the engine cover.

An electrical plug for the DC receptacle is supplied with your motor. Wire your charging or lighting cord to this plug.

WARNING Batteries produce explosive gases. Keep sparks, flames, and cigarettes away. To prevent the possibility of creating a spark near the battery, connect the charging cords first to the battery, then to the outboard motor, and disconnect the charging cords first at the outboard motor.

CAUTION:

- Connect the positive battery terminal to the positive charging cord. Do not reverse the charging cords, or serious damage to the outboard motor's charging circuit and/or battery may occur.
- When not in use, cover the DC receptacle with the rubber cover to keep it dry and clean.

DC RECEPTACLE

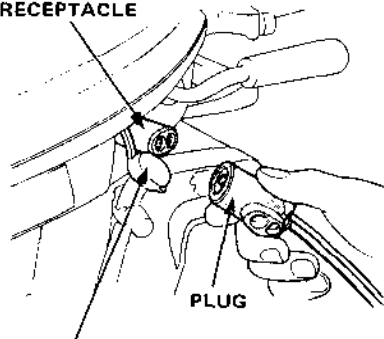

PLUG

RUBBER COVER

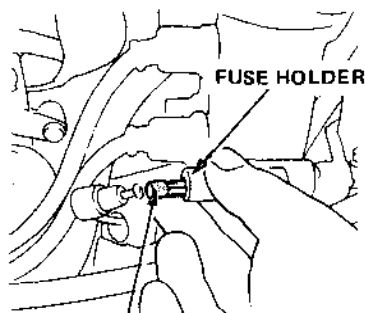

FUSE HOLDER

FUSE (5A)

8. STOPPING THE ENGINE

1. Turn the throttle grip to **SHIFT** and move the shift lever to **NEUTRAL**.

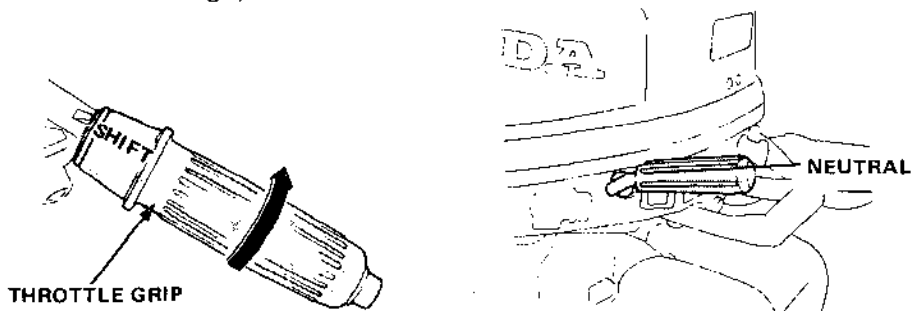

2. Push the stop button until the engine stops running.

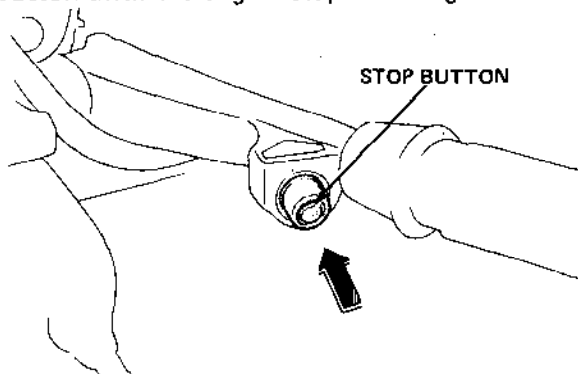

• High altitude operation

At high altitude, the standard carburetor air-fuel mixture will be excessively rich. Performance will decrease, and fuel consumption will increase.

High altitude performance can be improved by installing a smaller diameter main fuel jet in the carburetor and readjusting the pilot screw. If you always operate the outboard motor at altitudes higher than 6,000 feet above sea level, have your authorized Honda Outboard Motor dealer perform these carburetor modifications.

Even with suitable carburetor jetting, engine horsepower will decrease approximately 3.5% for each 1,000 foot increase in altitude. The affect of altitude on horsepower will be greater than this if no carburetor modification is made.

CAUTION: Operation of the outboard motor at an altitude lower than the carburetor is jetted for may result in reduced performance, overheating, and serious engine damage caused by an excessively lean air/fuel mixture.

9. MAINTENANCE

Periodic maintenance and adjustment are important to keep the motor in the best operating condition. Inspect or service as scheduled below.

WARNING Shut off the engine before performing any maintenance. If the engine must be run, make sure the area is well ventilated. The exhaust contains poisonous carbon monoxide gas.

CAUTION:

- If the engine must be run, make sure there is water at least 4 inches above the cavitation plate, otherwise the water pump may not receive sufficient cooling water, and the engine will overheat.
- To maintain cooling system efficiency, flush the outboard motor with fresh water after each use in salt water.
- Use only genuine HONDA parts or their equivalent. The use of replacement parts which are not of equivalent quality may damage the motor.

REGULAR SERVICE PERIOD Performed at every indicated month or operating hour interval, whichever comes first.		EACH USE	FIRST MONTH OR 20 HRS	EVERY 6 MONTHS OR 100 HRS	EVERY YEAR OR 200 HRS	Ref. Page
ITEM						
Engine oil	Check level	○				P. 27
	Change		○	○		P. 27
Gear case oil	Check	○				P. 28
	Change		○		○	P. 28
	Check for water contamination			○		—
Spark plugs	Clean-Readjust			○		P. 29
Carburetor Linkage	Check		○ (2)	○ (2)		—
Valve clearance	Check-Readjust		○ (2)		○ (2)	—
Fuel tank and fuel filter	Clean				○	—
Fuel strainer	Change				○	P. 33
Fuel line	Check (Replace if necessary)		Every 3 years			—
Thermostat	Check				○ (2)	—
Shear pin	Check			○		P. 32
Lubrication	Grease			○ (1)		P. 31

NOTE: (1) Lubricate more frequently when used in salt water.

(2) These items should be serviced by an authorized Honda dealer, unless the owner has the proper tools and is mechanically proficient. See the Honda Shop Manual.

Tool kit and spare parts

The following tools and spare parts are supplied with the outboard motor for maintenance, adjustment, and emergency repairs.

The tool kit and oil bottle are located in a compartment on the fuel tank. Spare shear pins and cotter pins are located on the stern bracket.

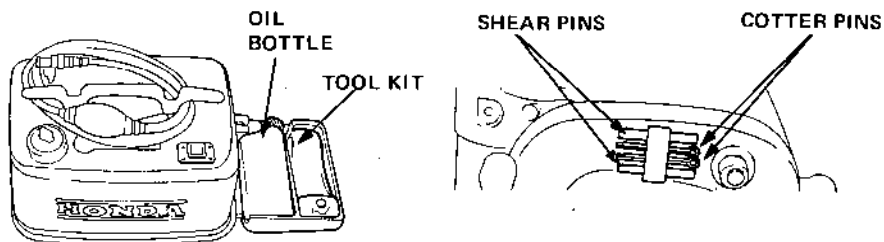

TOOL KIT

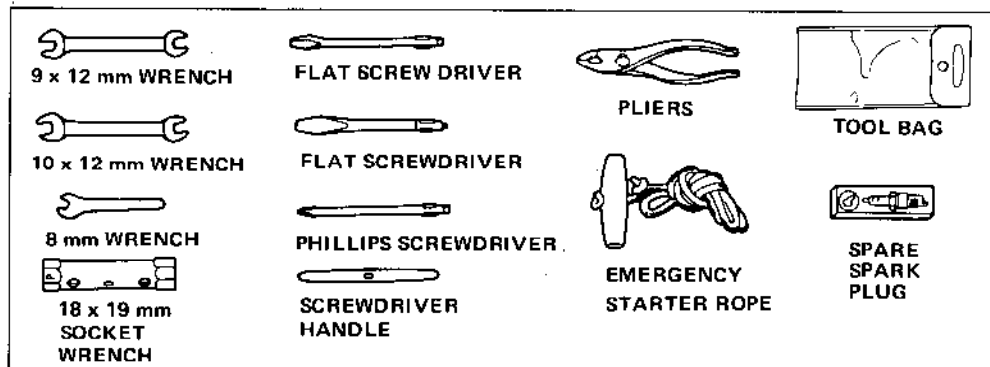

FLUSH KIT (See P. 28)

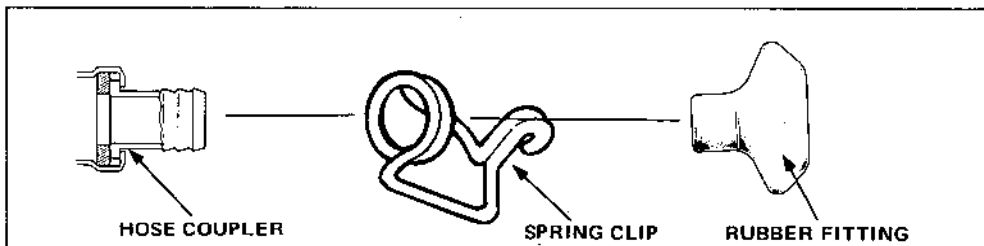

Engine Oil Change

Drain the oil while the engine is still warm to assure rapid and complete draining.

1. Remove the engine cover. Remove the drain screw and filler cap, and drain the oil. Reinstall the drain screw.
2. Fill the crankcase with the recommended oil (see page 10) and check the oil level with the dipstick resting on the filler opening (do not screw in). Fill to the 800 cc mark.

Oil capacity: 0.8 l (0.85 US qt)

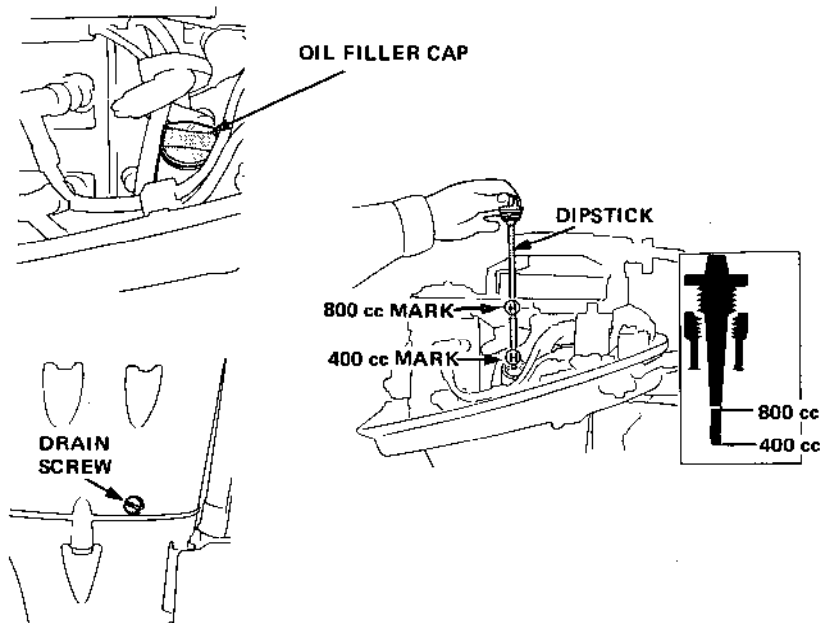

CAUTION: Used motor oil may cause skin cancer if repeatedly left in contact with the skin for prolonged periods. Although this is unlikely unless you handle used oil on a daily basis, it is still advisable to thoroughly wash your hands with soap and water as soon as possible after handling used oil.

NOTE: Please dispose of used motor oil in a manner that is compatible with the environment. We suggest you take it in a sealed container to your local service station for reclamation. Do not throw it in the trash or pour it on the ground.

Gear Oil Check/Change

Oil Level Check

Check the oil level when engine is in the vertical position. Remove the level screw and see if oil flows out. If no oil comes out, fill through the drain screw hole until the oil starts to flow out through the level screw hole. If there is water in the oil, the water will flow out first when the drain screw is removed, or the oil will be a milky color.

Oil Change

Remove the level screw and drain screw to drain the oil. Inject oil through the drain screw hole until it starts flowing out through the level screw hole. Reinstall and tighten the level screw and drain screw securely.

CAUTION: If water is detected in the oil, the unit should be inspected by an authorized Honda dealer.

Recommended Oil: API standard (GL-4 or GL-5)
SAE 90 outboard motor gear oil
Oil capacity: 0.23 l (0.49 US pt)

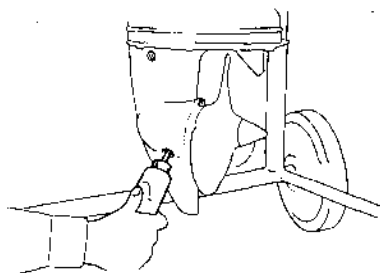
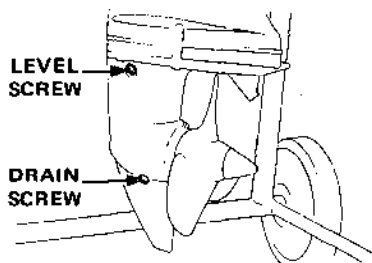

Spark Plug Service

Recommended spark plug: DR-5HS (NGK), X16FSR-U (ND)

1. Remove the engine cover.
2. Remove the spark plug cap.
3. Use the wrench supplied in the tool kit to remove the spark plug.
4. Visually inspect the spark plug. Discard it if the insulator is cracked or chipped. Clean the spark plug with a wire brush if it is to be reused.
5. Measure the plug gap with a feeler gauge.
The gap should be 0.6–0.7 mm (0.024–0.028 in). Correct as necessary by bending the side electrode.
6. Attach the plug washer. Thread the plug in by hand to prevent cross-threading.
7. Tighten a new spark plug 1/2 turn with the wrench to compress the washer. If you are reusing a plug, it should only take 1/8–1/4 turn after the plug seats.
8. Reinstall the engine cover.

CAUTION:

- The spark plug must be securely tightened. An improperly tightened plug can become very hot and possibly damage the engine.
- Never use a spark plug with an improper heat range.

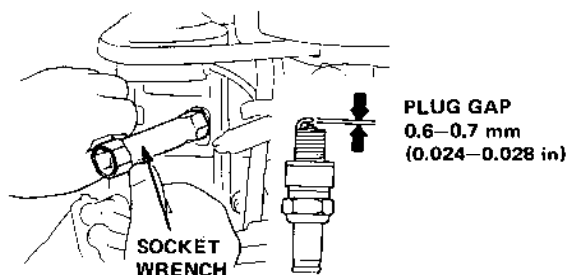

Cleaning and Flushing

After each use in salt water or dirty water, thoroughly clean and flush the outboard motor.

1. Wash the outside of the outboard motor with clean, fresh water.
2. Flush the cooling system, using the Honda flush kit supplied with the outboard motor.
 - a. Attach a hose from a fresh water faucet to the flush kit hose coupler.
 - b. Remove the propeller, and clip the flush kit rubber fitting over the water intake as shown.
 - c. Turn on the fresh water supply to the hose.
 - d. Start the engine and run in neutral for 10 minutes.

WARNING

- For safety, the propeller must be removed.
- Be sure the outboard motor is securely mounted, and do not leave it unattended while running.

CAUTION: Running the engine without water can cause serious engine damage due to overheating. Be sure that water flows from the water check tube while the engine is running. If not, stop the engine and determine the cause of the problem.

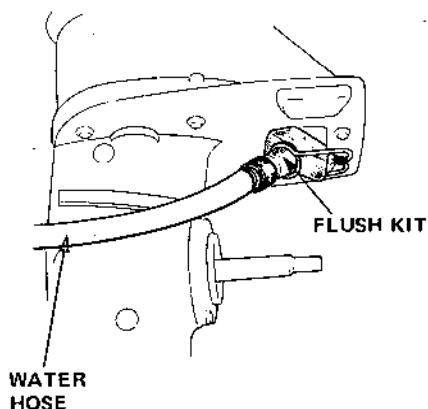
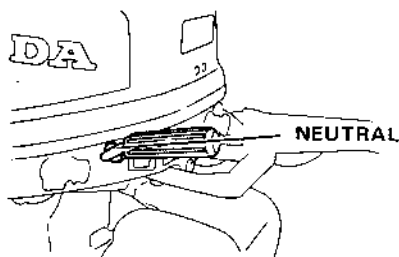

Lubrication

Wipe the outside of the engine with a cloth dipped in oil. Apply marine anti-corrosion grease to the following parts:

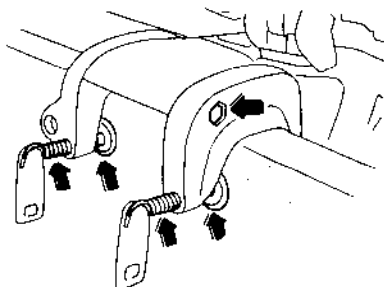

CLAMP SCREWS



THROTTLE CABLE AND PIVOT
SHIFT SHAFT AND PIVOT

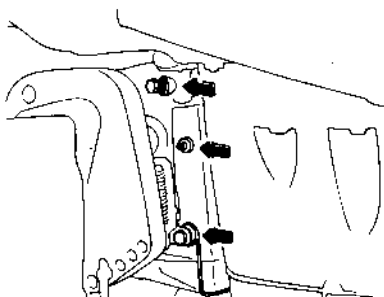

SWIVEL CASE

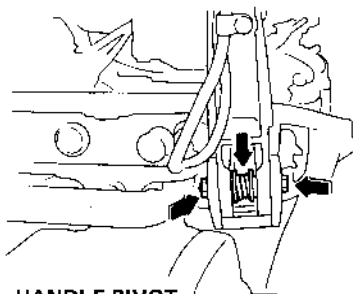

HANDLE PIVOT

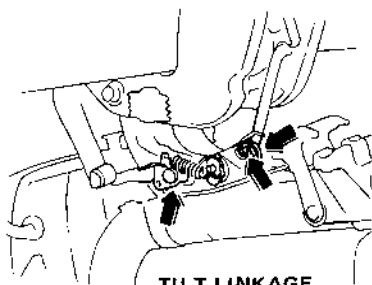

TILT LINKAGE

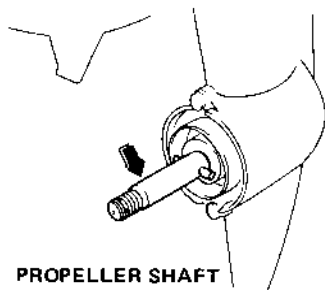

PROPELLER SHAFT

NOTE: Apply anti-corrosion oil to pivot surfaces where grease cannot penetrate.

Shear Pin Change

A shear pin is used to protect the propeller and drive mechanism from damage when the propeller strikes an obstruction.

1. Remove the cotter pin, the propeller cap, and the propeller.
2. Remove the broken shear pin and replace it with a new one.
3. Install the propeller, then install the propeller cap finger tight.
4. Install a new cotter pin, and spread the ends as shown in the illustration.

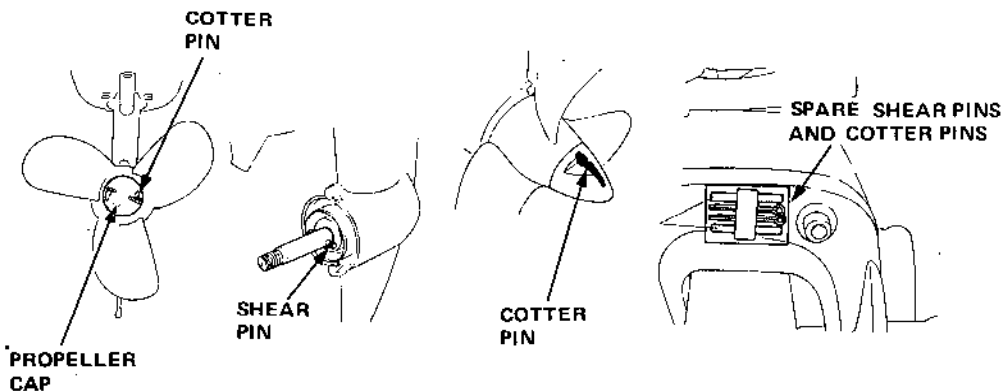

Fuel strainer replacement

The fuel strainer is located between the fuel pump and the carburetor. Water or sediment accumulated in the fuel strainer can cause loss of power or hard starting. To prevent engine malfunction, replace the fuel strainer regularly.

((SERVICE PERIOD)) Every 200 operating hours or every one year.

WARNING

- Gasoline is flammable and explosive under certain conditions. Do not smoke or allow flames or sparks near the outboard motor while draining fuel.
- Always work in a well-ventilated area.
- Be sure that any fuel drained from the outboard motor is stored in a safe container.
- Wipe up any spilled gasoline at once.

1. Disconnect the fuel tank line from the motor.
2. Remove the engine cover, and remove the fuel strainer.

NOTE: Before removing the strainer, place clamps on the fuel tubes on each side of the strainer to prevent fuel leakage.

3. Install the new fuel strainer with the arrow mark pointing toward the carburetor.

NOTE: Fuel flow will be impeded if the strainer is installed backward.

-
4. Remove the clamps used to close the fuel tubes. Connect the fuel tank line to the motor. Turn the fuel tank vent knob to the ON position, pump the primer bulb, and check for leaks.

Contact an authorized Honda dealer if you find excessive water or sediment accumulated in the fuel strainer.

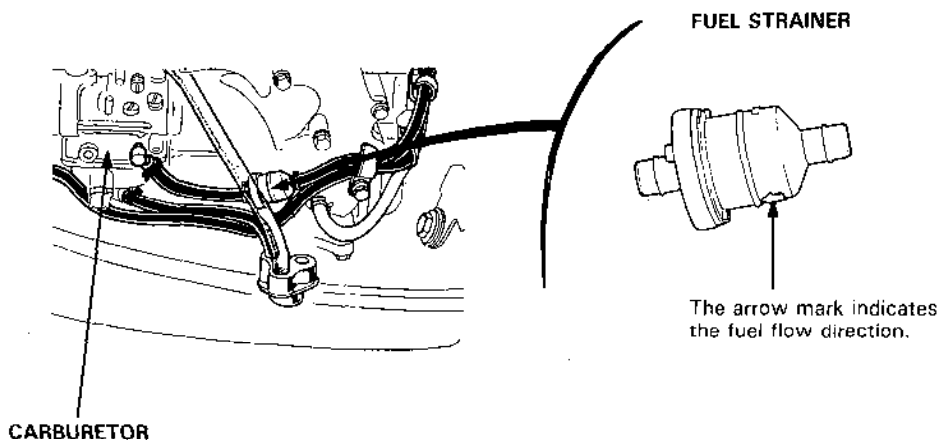

Servicing a Submerged Motor

A submerged motor must be serviced immediately after it is recovered from the water in order to minimize corrosion.

If there is a Honda outboard motor dealership nearby, take the motor immediately to the dealer. If you are far from a dealership, proceed as follows:

1. Remove the engine cover, and rinse the motor with fresh water to remove salt water, sand, mud, etc.
2. Loosen the carburetor drain screw (p. 36), drain the contents of the carburetor into a suitable container, then retighten the drain screw.
3. Change the engine oil (p. 27). If there was water in the engine crankcase, or the used engine oil showed signs of water contamination, then a second engine oil change should be performed after running the engine for 1/2 hour.
4. Remove the spark plugs. While pressing the engine stop button, pull the recoil starter several times to completely expel water from the cylinders.

CAUTION:

- When cranking the engine with an open ignition circuit (spark plugs removed from the ignition circuit), keep the engine stop button depressed to prevent electrical damage to the ignition system.
 - If the motor was running when it submerged, there may be mechanical damage, such as bent connecting rods. If the engine binds when cranked, do not attempt to run the motor until it has been repaired.
5. Pour a teaspoon of engine oil into each spark plug hole, then pull the recoil starter several times to lubricate the inside of the cylinders. Reinstall the spark plugs.
 6. Attempt to start the engine.
 - If the engine fails to start, remove the spark plugs, clean and dry the electrodes, then reinstall the spark plugs and attempt to start the engine again.
 - If the engine starts, and no mechanical damage is evident, continue to run the engine for 1/2 hour or longer (be sure the water level is at least 4 inches above the cavitation plate).
 7. As soon as possible, take the motor to a Honda outboard motor dealer for inspection and service.

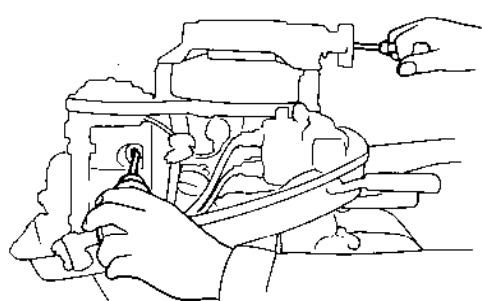
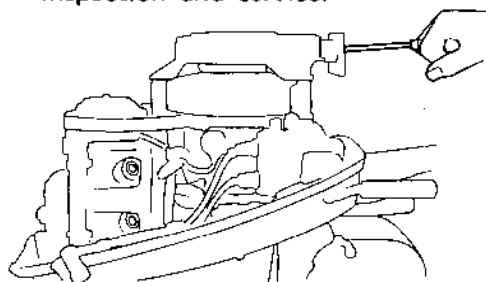

10. TRANSPORTING/STORAGE

1. Disconnect the fuel line and install the cap on the engine fuel inlet. Firmly close the fuel cap vent knob.

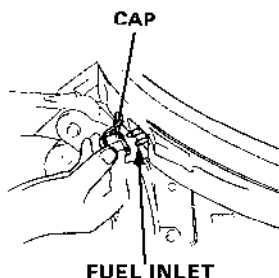
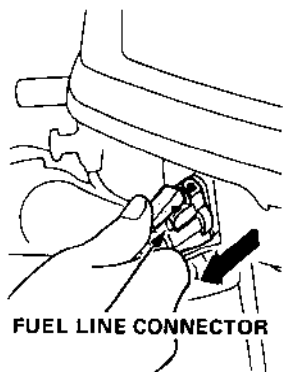

2. Loosen the carburetor drain screw, and drain the gasoline into a suitable container. After draining, retighten the drain screw.

WARNING Be careful not to spill fuel. Fuel vapor or spilled fuel may ignite.

CAUTION: In cold weather, to prevent ice from forming inside the water pump, pull the recoil starter several times to flush the water out.

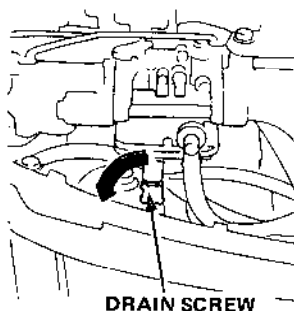

3. To carry, hold the motor by the carrying handle, or hold by the carrying handle and engine cover lock lever as shown here. Do not carry by the engine cover.

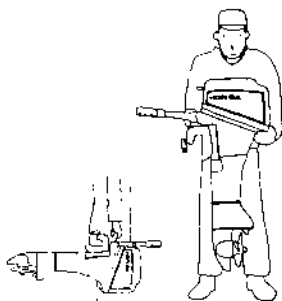

4. Transport and store the motor either vertically or horizontally, as shown here, with the steering handle raised.

Vertical transport or storage: Attach the stern bracket to a stand.

Horizontal transport or storage: Rest the motor on the case protector (steering handle side of the motor).

CAUTION:

- Any other transport or storage position may cause damage or oil leakage.

5. Store the outboard motor in a clean, dry area.

NOTE: Before storing, clean, flush, and lubricate the outboard motor as described on pages 30 and 31.

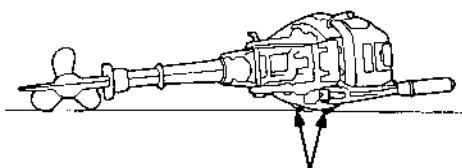
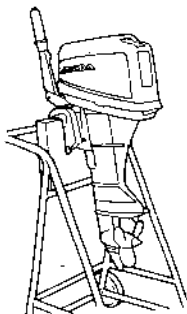

CASE PROTECTOR



11. TROUBLESHOOTING

Engine Will Not Start:

1. Is the shift lever in neutral?
2. Is there fuel in the fuel tank?
3. Is the fuel cap knob turned to ON?
4. Is the fuel system primed by squeezing the primer bulb?
5. Is fuel reaching the carburetor?

Loosen the carburetor drain screw to see if there is fuel in the carburetor float bowl.

 **WARNING** If any fuel is spilled, make sure the area is dry before testing the spark plug or starting the engine. Fuel vapor and spilled fuel may ignite.

6. Are the spark plugs firing?
 - a. Remove and inspect the spark plugs. Clean and dry the plugs, and check the electrode gap (p. 29).
 - b. Install both spark plugs in their caps, and ground the side electrodes to each other or to any engine ground.
 - c. Pull the recoil starter briskly, and see if the plugs spark.
 - d. If the spark plugs are OK, reinstall them, and try to start the engine.

Engine Overheats:

1. Is the water intake screen clogged?
2. Is the thermostat faulty?

12. SPECIFICATIONS

Item	Specification
Output	7.5 horse power (Maximum) (BF75) 9.9 horse power (Maximum) (BF100)
Full throttle range	4,800–5,200 rpm (BF75) 5,000–5,700 rpm (BF100)
Engine type	4-stroke OHC in-line twin cylinder
Displacement	197 cc (12.0 cu in)
Valve tappet clearance	0.06–0.1 mm (0.002–0.004 in)
Spark plug gap	0.7 mm (0.028 in)
Starter system	Recoil starter
Ignition system	C.D.I.
Lubrication system	Trochoid pump pressure lubrication
Specified oil	Engine: API standard (SE or SF) SAE 10W-40 Gear case: API standard (GL-4/5) SAE 90 outboard motor gear oil
Oil capacity	Engine: 0.8 ℓ (0.85 US qt) Gear case: 0.23 ℓ (0.49 US pt)
D.C. output	12V–60W
Cooling system	Water cooling with thermostat (volumetric pump)
Exhaust system	Underwater exhaust
Spark plugs	DR-5HS (NGK), X16FSR-U (ND)
Fuel pump	Diaphragm type fuel pump
Fuel	Automotive gasoline (91 research octane, 86 pump octane)
Tank capacity	13 ℓ (3.4 US gal)
Steering equipment	Bar handle
Tilt angle	2-stage adjustment (32.5° and 72°)
Angle of rotation	45° (both sides)
Overall length x height x width	S Model: 515 x 1010 x 315 mm (20.28 x 39.76 x 12.4 in) L Model: 515 x 1160 x 315 mm (20.28 x 45.67 x 12.4 in)
Height from stern bracket to anticavitation plate	S Model: 422 mm (16.61 in) L Model: 572 mm (22.52 in)
Standard Propeller (No. of blades - diameter x pitch)	3 - 240 x 220 mm (9-1/2 x 8-5/8 in)
Gear change	Forward - Neutral - Reverse (dog type)
Dry weight	S Model: 34.0 kg (74.97 lb) L Model: 35.0 kg (77.18 lb)

13. WIRING DIAGRAM

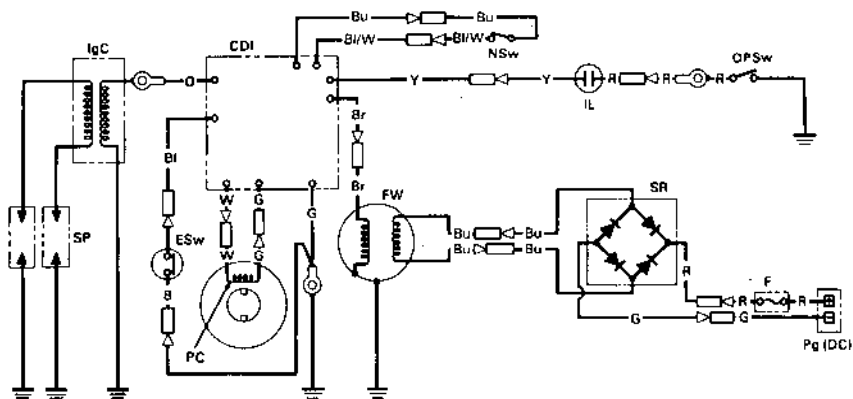

Component Identification

SP	Spark Plug
IgC	Ignition Coil
ESw	Engine Stop button
FW	Fly Wheel
SR	Silicon Rectifier
IL	Indicator Lamp
OPSw	Oil Pressure Switch
F	Fuse
Pg (DC)	DC Plug
CDI	CDI unit
PC	Pulser Coil
NSw	Neutral Switch

Wire color

BI	Black
Y	Yellow
Bu	Blue
G	Green
R	Red
Br	Brown
W	White
O	Orange
BI/W	Black/White

14. OPTIONAL PARTS

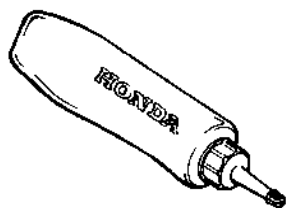

GEAR OIL

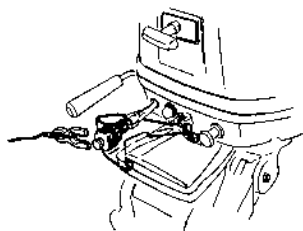

**EMERGENCY ENGINE
STOP SWITCH**

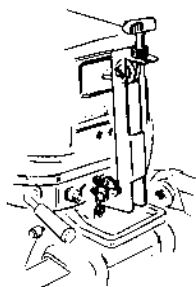

VERTICAL STARTER

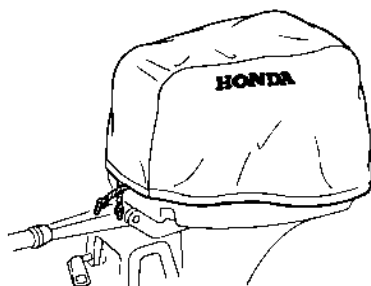

ENGINE COVER

15. WARRANTY SERVICE

Owner Satisfaction

Your satisfaction and goodwill are important to your dealer and to us. All Honda warranty details are explained in the Distributor's Limited Warranty. Normally, any problems concerning the product will be handled by your dealer's service department. If you have a warranty problem that has not been handled to your satisfaction, we suggest you take the following action:

- Discuss your problem with a member of dealership management. Often complaints can be quickly resolved at that level. If the problem has already been reviewed with the Service Manager, contact the owner of the dealership or the General Manager.
- If your problem still has not been resolved to your satisfaction, contact the Power Equipment Customer Relations Department of American Honda Motor Co., Inc.

American Honda Motor Co., Inc.
Power Equipment Customer Relations Department
P.O. Box 50
Gardena, California 90247-0805
Telephone: (213) 604-2400

We will need the following information in order to assist you:

- Your name, address, and telephone number
- Product model and serial number
- Date of purchase
- Dealer name and address
- Nature of the problem

After reviewing all the facts involved, you will be advised of what action can be taken. Please bear in mind that your problem will likely be resolved at the dealership, using the dealer's facilities, equipment, and personnel, so it is very important that your initial contact be with the dealer.

Your purchase of a Honda product is greatly appreciated by both your dealer and American Honda Motor Co., Inc. We want to assist you in every way possible to assure your complete satisfaction with your purchase.

MEMO

MEMO



HONDA
HONDA MOTOR CO., LTD. TOKYO, JAPAN

31882621
00X31-882-6211

Ⓢ Ⓞ H008903F
PRINTED IN JAPAN